

GIOVANNONI SERIES

Washlet
TCF892G

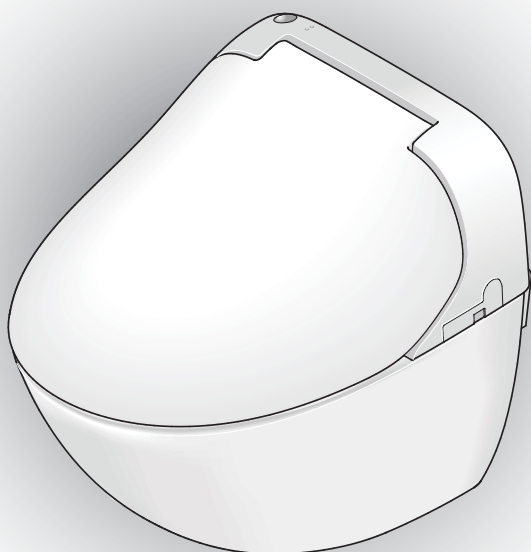

washlet®

■ Thank you very much for purchasing this Washlet. Please read this manual carefully and use the Washlet correctly. Keep this instruction manual for future reference.
 ■ "Washlet" is a registered trademark of TOTO.

Cautions and warnings	2	Introduction
Precautions for use	6	
Efficient use	7	
Overview of features	8	
Names of parts	9	
Before use	11	
How to use the Washlet	13	Operation
Convenient functions	15	
● Adjusting the temperature	15	
● Using the deodorizer	16	
Energy Saver function	17	
● Using the Energy Saver timer	17	
Cleaning the Washlet	19	Cleaning
● Before cleaning	19	
● Daily cleaning	19	
● Thorough cleaning	20	
• Cleaning between the main Washlet unit and the toilet	22	
● Periodic cleaning	23	
• Cleaning the mains plug	23	
• Cleaning the deodorizer filter	23	
• Cleaning the wand	24	
• Cleaning the water supply filter	25	
Changing settings	27	Settings
● Setting whether or not the remote control makes sound	27	
● Setting automatic operation of the standard deodorizer	27	
● Making the Power Deodorizer work automatically	27	
● Water pressure and washing position	28	
Preventing damage from freezing and measures for long-term disuse	29	Troubleshooting
Troubleshooting	34	
Specifications	39	
Warranty	40	
Important User Guidance Information	41	

Cautions and warnings

Always observe these warnings.

Please read these cautions and warnings carefully and use the equipment correctly.





Follow all safety precautions and warnings.

- The meanings of these indications are as follows.



	WARNING	When this appears next to a topic, this indicates that misoperation could result in death or serious injury.
---	----------------	--

	CAUTION	When this appears next to a topic, this indicates that misoperation may result in injury or physical damage.
---	----------------	--

- The following symbols are used to classify and explain instructions that must be followed.

Symbol example	Meaning of symbol
	The  symbol indicates something that is prohibited.
	The  symbol indicates something that is prohibited.

- This equipment is Class 1, so it is necessary to attach it to an earthed connection.
- Install this equipment close to a mains socket.
- This equipment is not to be used by any person who has reduced physical, sensory or mental abilities (including children), nor is it to be used by any person who lacks sufficient experience or knowledge. However, such persons may use the equipment when a person who takes responsibility for their safety provides supervision and direction. Children must be supervised to make certain that they do not play with the equipment.
- Use the new hose set included with this equipment. Do not reuse an old hose set.

 WARNING	
 Do not wet	<p>Do not wet the main Washlet unit or mains plug with water or cleaning fluid.</p> <ul style="list-style-type: none"> Doing so could cause fire or electric shock.
 Required	<p>Since this is electronic equipment, do not locate it in a place where it might be splashed or otherwise become wet. Likewise, do not locate it in a humid place where water could drip onto the surface of the Washlet. When using it in a bathroom, install a ventilation fan or ventilation opening, so that the bathroom has sufficient airflow.</p> <p>Install the Washlet at least 0.6 m away from any bathtub.</p> <ul style="list-style-type: none"> Failure to observe this caution may result in fire or electrical shock. <p>Prepare the socket for the electrical wiring as follows.</p> <ul style="list-style-type: none"> Failure to observe this caution may result in fire or electrical shock. <ol style="list-style-type: none"> Provide electric current to the socket (device) using a differential residual electric current device (DDR) with a released current that does not exceed 30 mA. Locate the socket (device) and its wiring plug at least 0.6 m from the outside edge of a shower chamber or bathtub. * Confirm that the wiring for items a and b above has been completed. If the wiring has not been completed, request completion from the business that installed the unit.

! WARNING

Confirm that the earth wire has been installed properly.

- If the earth wire is not installed, electric shocks could occur if there is a malfunction or a short circuit.

Note:

Use copper wire with a diameter of 1.6 mm or more and with an earth resistance of 100 Ω or less.

- * If the earth wire has not been installed, request installation from the business that installed the unit.

Always insert the electrical cord completely into the socket (220-240 V AC, 50 Hz).

- Failure to observe this caution may result in fire or electrical shock.

- * Follow the installation requirements for the country in which the Washlet is being installed.

Always connect the Washlet to the cold water supply.

- Failure to do so could cause burns or malfunction of the equipment.

Ventilation fan or ventilation opening

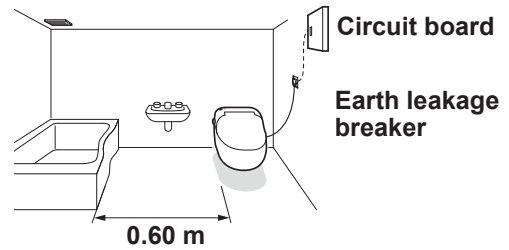

Be careful to prevent low-temperature burns.

- When seated on the Washlet for a long time, set the seat temperature to "off".
- Another person should turn the seat temperature to "off" before the following types of people use the Washlet.

- Children, elderly and other people who cannot adjust the temperature suitably themselves.
- Sick or physically disabled people and others who might not be able to move freely.
- People who have taken medication that causes drowsiness (sleep aids, cold medicine, etc.), people who have drunk much alcohol, extremely fatigued people and others who might fall asleep unintentionally.



Required

Remove dust that has adhered to the mains plug blades or other parts regularly and insert it in the socket completely.

- Dust could cause fire or electrical shock.
- Remove the plug and wipe it with a dry cloth.

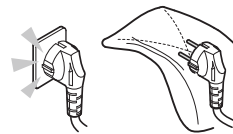

When removing the mains plug, always hold and pull the plug itself.

- If you pull on the cord, the plug and cord could be damaged, and fire or electrical shock could result.

To reduce the danger of burns, death from electric shock, fire or other human injury:

- Close supervision is necessary when this product is used by or near children or invalids.
- Use this product only for its intended use as described in this manual. Do not use accessories not recommended by the manufacturer.
- Keep the cord away from heated surfaces.
- Connect this product to a properly earthed socket only. See the Earthing Instructions.
- The tank should only be filled with water.



Do not disassemble

Never disassemble, repair or modify the device.

- This could cause fire or electric shock.



Do not touch with wet hands

Do not remove the mains plug with wet hands.

This could cause electric shock.

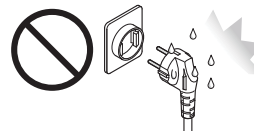

⚠ WARNING

Do not continue to use Washlet that is broken or malfunctioning.

- In the following situations, disconnect the mains plug and close the water shut-off valve to stop the water supply.

Possible malfunctions

- Water is leaking from plumbing or the main unit.
- The Washlet has a crack or a break.
- There is a strange sound or smell.
- Smoke is coming from the Washlet.
- The Washlet is unusually hot.

- Continued use of a malfunctioning or broken unit could cause fire, electric shock, or flooding of the room containing the unit.

Do not do anything that could damage the power cord or seat cord.

Do not pull, twist, excessively bend, intentionally damage, alter or heat the cords. Do not put heavy items on them.

- Continued use of a unit with a damaged cord could cause fire, electric shock, or a short circuit.

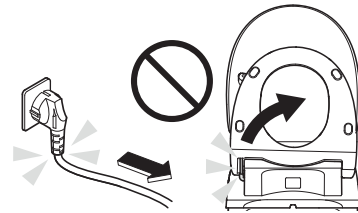

Prohibited

Do not use a loose mains socket.

- This could cause fire or electric shock.

Do not use this product with any power supply other than specified (220-240 V AC, 50 Hz).

- Failure to observe this caution may result in fire or electrical shock.

Do not use sockets or wiring equipment exceeding the rated values.

- Use of multi-prong mains adapters and other actions that exceed the rated values could cause fire from excess heat.

Use only tap water or potable well water (groundwater).

- Use of other water could cause skin inflammation or other problems.

To reduce the danger of burns, death from electric shock, fire or other human injury:

- Never operate this product if it has a damaged cord or plug, if it is not working properly, if it has been dropped or damaged, or if it has been dropped in water. Return the product to TOTO Europe GmbH for examination and repair.
- Never block the air openings of the product or place it on a soft surface, such as a bed or a couch, where the air openings could be blocked. Keep the air openings free of lint, hair or a similar material.
- Never use it while sleepy or drowsy.
- Never drop or insert anything into any opening or hose.
- Do not use outdoors or operate where aerosol (spray) products are being used or where oxygen is being administered.

Always disconnect the mains plug from the socket when cleaning.

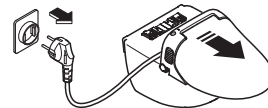

Failure to do so could cause electric shock.

- * Use of the "Wand Cleaning button" is an exception to this rule.



Unplug first

⚠ CAUTION

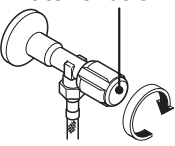
 Flammable	<p>Do not bring lit cigarettes or other burning materials near the Washlet.</p> <ul style="list-style-type: none"> • Doing so could cause fire.
 Prohibited	<p>When cleaning plastic parts, including the main Washlet unit, use diluted (pH-neutral) kitchen cleaning detergent. Do not use the following:</p> <p>Toilet cleaner, household cleaner, benzine, paint thinner, cleanser powders, nylon scrubbing pads, etc.</p> <ul style="list-style-type: none"> • These could damage the plastic or cause cracks, which could lead to injury. • These could damage the water supply hose, resulting in water leaks.
	<p>Do not subject the main Washlet unit to strong force or a sudden shock. Do not climb on the seat, the toilet lid or any other part of the main Washlet unit. Do not put heavy objects on it.</p> <ul style="list-style-type: none"> • Injury could result if it breaks or the main Washlet unit becomes dislodged and falls.
	<p>Do not lift the Washlet by the seat or toilet lid.</p> <ul style="list-style-type: none"> • Injury could result if the main Washlet unit becomes dislodged and falls.
	<p>Do not detach the drain valve with built-in water filter while the water shut-off valve is still open.</p> <ul style="list-style-type: none"> • Doing so will cause water to spill. <p style="text-align: right;">▶ See "Cleaning the water supply filter" on page 24</p>
	<p>Do not bend or crush the water supply hose.</p> <ul style="list-style-type: none"> • This could cause a water leak.
	<p>To reduce the danger of death from electric shock:</p> <ul style="list-style-type: none"> - Do not use while bathing. - Do not place or store the product where it could fall or be pulled into a tub or sink. - Do not put in or drop into water or other liquid. - Do not try to recover it if it has fallen into water. Unplug it immediately.
 Required	<p>If the Washlet will not be used for a long time, close the water shut-off valve, drain the water and disconnect the mains plug.</p> <p style="text-align: right;">▶ See "Draining the water" on page 29</p> <ul style="list-style-type: none"> • For safety, disconnect the mains plug. • Run water through the Washlet before using it again because water left in the unit may have spoiled and could cause skin inflammation or other problems. <p style="text-align: right;">▶ See "Restoring the water supply after draining the Washlet" on page 33</p>
	<p>If a water leak occurs, close the water shut-off valve and stop the water supply.</p> <p style="text-align: center;">Water shut-off valve</p>  <p style="text-align: center;">Turn clockwise</p>
	<p>Thoroughly tighten the drain valve with built-in water filter.</p> <ul style="list-style-type: none"> • Failure to do so could cause a water leak.
	<p>Prevent damage from freezing.</p> <ul style="list-style-type: none"> • Freezing could cause damage to the water supply plumbing and the inside of the Washlet and result in a leak. • Use a heater or otherwise keep the toilet warm. <p style="text-align: right;">▶ See "Preparation for freezing conditions" on page 29</p>

Earthing Instructions

This product must be earthed. If an electrical short circuit occurs, earthing reduces the risk of electric shock by providing an escape wire for the electrical current. This product is equipped with a cord that has an earth wire and an earthing plug. The plug must be plugged into a socket that is properly installed and earthed.

Improper use of the earthing plug can result in the risk of an electric shock.

If the cord or plug requires repair or replacement, do not connect the earthing wire to either of the flat blade terminals. The earth wire has insulation that is green on the outside and might or might not have yellow stripes. Check with a qualified electrician or serviceman if you do not completely understand the earth wire instructions or have a doubt about whether the product is properly earthed.

This product is equipped at the factory with a specific electrical cord and plug that allow connection to a suitable electrical circuit. Confirm that the product is connected to a socket with the same configuration as the plug. Do not use an adapter with this product. Do not modify the included plug. If the plug and socket are not compatible, have a suitable socket installed by a qualified electrician. If the product must be reconnected for use with a different type of electrical circuit, qualified service personnel must conduct the reconnection.

If it is necessary to use an extension cord, use only a three-wire extension cord that has a three-blade earthing plug and a three-slot socket that accepts the plug on the product cord. Replace or repair a damaged cord.

Save these instructions.

Precautions for use

Please follow these instructions regarding the Washlet.

Do not wipe the main unit, seat or toilet lid with dry cloth, toilet paper or similar materials.

▶ "Cleaning the Washlet" on page 19

Do not expose to direct sunlight.

- Direct exposure could cause changes in colour or irregular temperature in the heated seat, as well as malfunction of the remote control.

Avoid urinating on the main unit and wand.



Do not cover the seat sensor or the signal transmission area of the remote control.

- This could cause the Washlet to function incorrectly.



Do not lean against the toilet lid.



Disconnect the mains plug during thunderstorms.

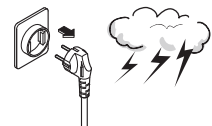

Do not give a shock to the remote control.

- Trouble may result. To prevent the remote control from dropping, set it on the remote control holder when not in use. Take care to prevent it from getting wet.

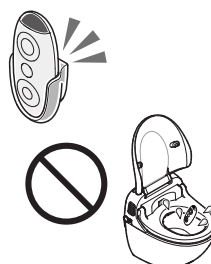

Use radios and similar devices at a distance from the Washlet.

The Washlet could cause interference to the radio signal.

Efficient use

Skilfully save energy to protect the global environment.

Using the timer-based Energy Saver

Once the Energy Saver is set, the warm water and seat heaters will turn off at the same time every day to save energy. The duration of the Energy Saver can be set to 3, 6 or 9 hours.

► See page 18

3-hour Energy Saver in use

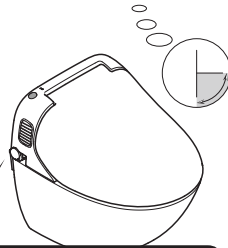

Timer-based Energy Saver in use

Close the toilet lid

By closing the toilet lid, less warmth escapes from the seat surface, conserving energy.

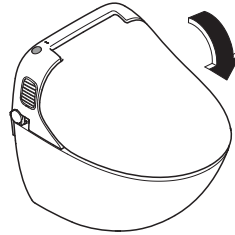

Set the temperature lower

To conserve energy set the temperature just high enough so that the seat does not feel cold.

► See page 16

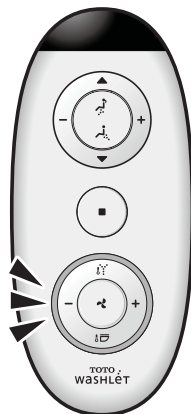

Set the Operation on/off button to "off" when the Washlet will not be used for a long time

When going out, for example, set the  button to "off" to conserve energy.

► See page 12

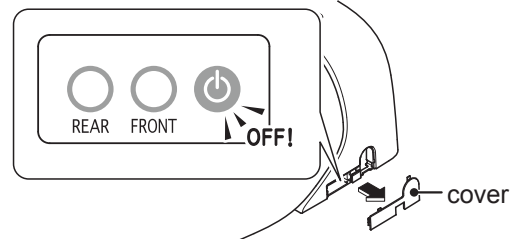

Overview of features

Washlet functions		Page
Rear wash	<ul style="list-style-type: none"> Wash the rear. 	14
Front wash	<ul style="list-style-type: none"> Use as a bidet for women. 	14
Washing position adjustment	<ul style="list-style-type: none"> Adjust the wand position forward and backward. 	14
Water pressure adjustment	<ul style="list-style-type: none"> Adjust the water pressure. 	14
Oscillating wash	<ul style="list-style-type: none"> Moves the wand forward and backward for thorough cleaning over a wide area. 	14

Amenities		Page
Heated seat	<ul style="list-style-type: none"> Warms the toilet seat. 	-
Temperature adjustment	<ul style="list-style-type: none"> Adjust the temperature of the water and the seat. 	16
Deodorizer	<ul style="list-style-type: none"> Eliminates odours inside the toilet. 	17
Power Deodorizer	<ul style="list-style-type: none"> Eliminates odours inside the toilet with even greater suction power. 	17
Automatic Power Deodorizer	<ul style="list-style-type: none"> Automatically operates the Power Deodorizer when a person leaves the seat. 	17
Remote control	<ul style="list-style-type: none"> Control the Washlet from a comfortable position. 	10
Seat sensor	<ul style="list-style-type: none"> Makes various functions operate when a person sits on the seat. 	14
Soft closing	<ul style="list-style-type: none"> Closes the seat and toilet lid slowly. 	-



Energy Saver functions		Page
Timer-based Energy Saver	<ul style="list-style-type: none"> Once set, the warm water and seat heaters will turn off at the same time every day to save energy. (The duration of Energy Saver can be set to 3, 6 or 9 hours.) 	18,19
Operation on/off button	<ul style="list-style-type: none"> By turning this button "off", the operation of the heated seat and other functions can be stopped for thorough energy conservation. 	12

Cleaning features		Page
One-touch attachment and removal of the main unit	<ul style="list-style-type: none"> The main Washlet unit can be removed with a simple operation allowing easy access to the back of the toilet for cleaning. 	21
Self-cleaning	<ul style="list-style-type: none"> The wand tip is automatically cleaned thoroughly before and after washing. 	-
Wand Cleaning	<ul style="list-style-type: none"> The wand can be extended without emitting water for easy cleaning. 	23

Names of parts

Product stock number and type printed here.

Washlet main display section

- "POWER" indicator  POWER
- "ENERGY SAVER" indicator  ENERGY SAVER

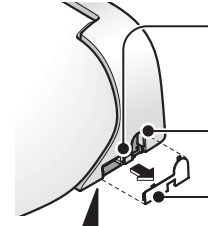

Washlet main operation section

REAR button ▶ See page 15

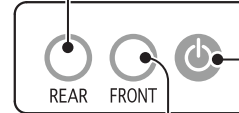

FRONT button ▶ See page 15

Use when the remote control battery is dead, for example.

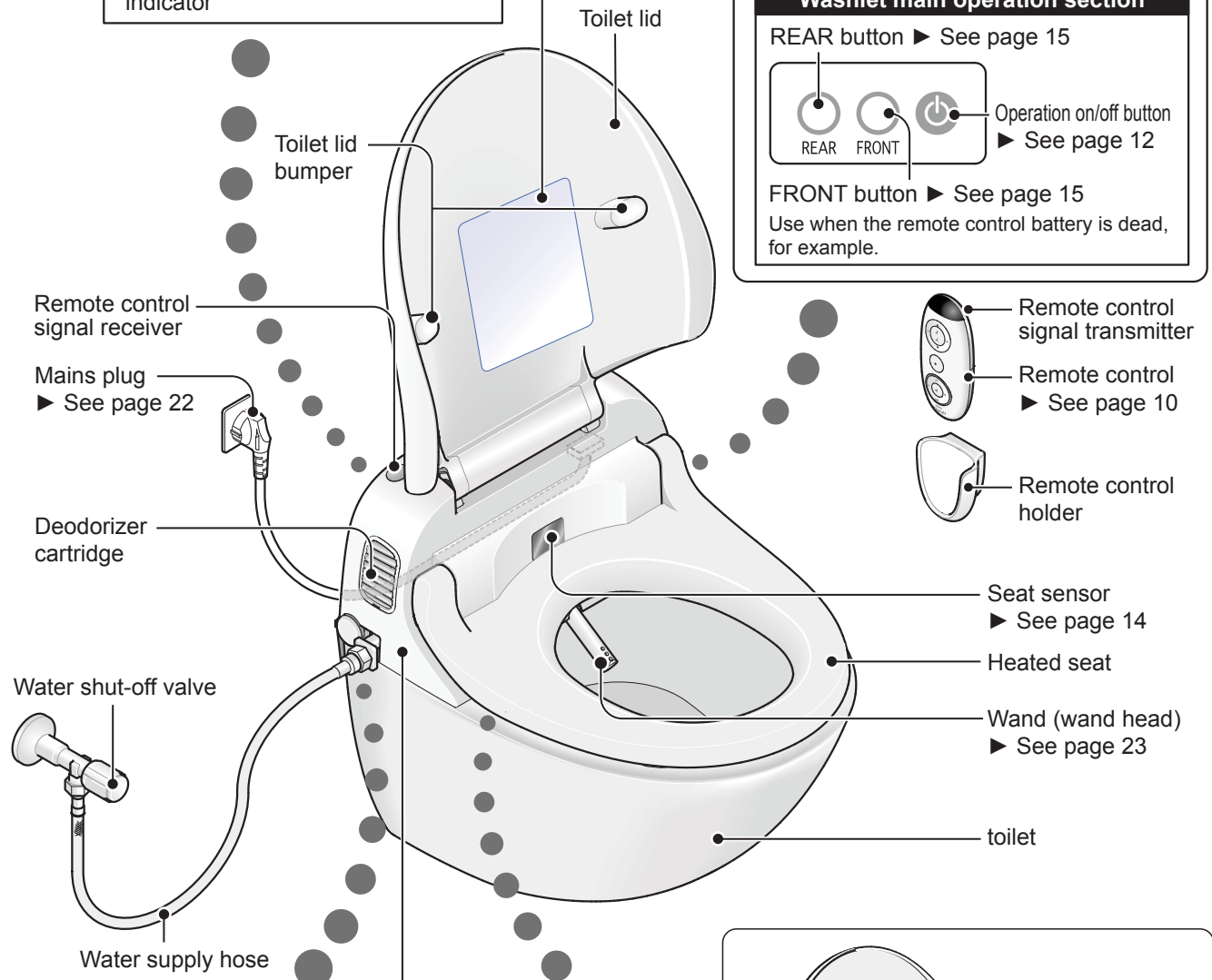
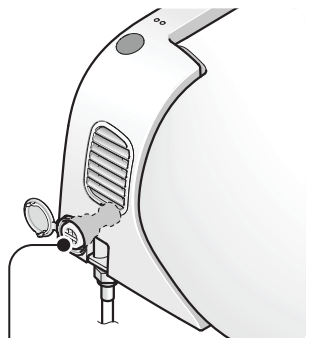
Drain valve with built-in water filter
▶ See page 30

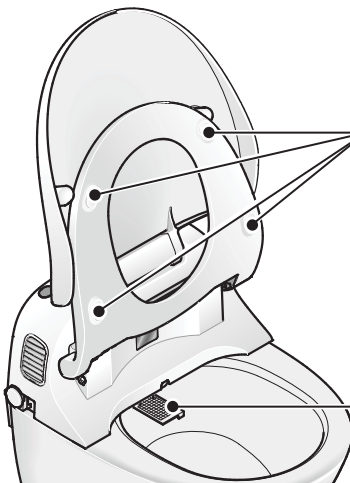

Seat cushion

Deodorizer filter
▶ See page 22

Remote control

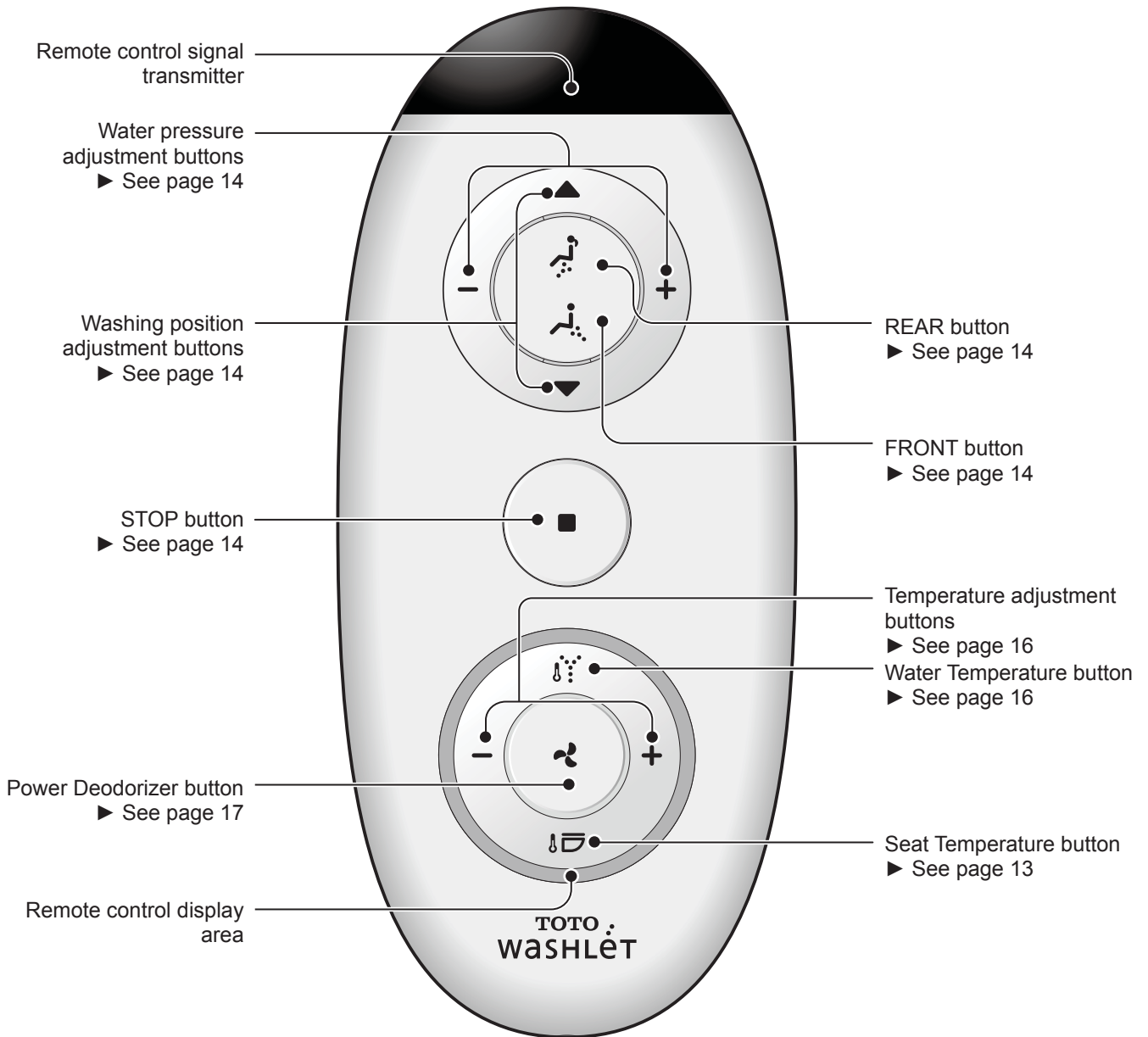

About the electronic sounds

- When a remote control button is pressed and the main Washlet unit receives a signal, the unit produces an electronic sound. This unit uses three types of electronic sounds.

Short beepSounds when a remote control button is pressed and the main Washlet unit receives a signal.

Long beepSounds when the STOP button is pressed, when any function (timer-based Energy Saver, oscillating wash, etc.) is turned off or when the setting mode is exited.

Double beep.....Sounds when the Water Temperature or Seat Temperature is set to their "STEP5" settings.

▶ See page 26 for how to turn off the remote control sound.

Before use

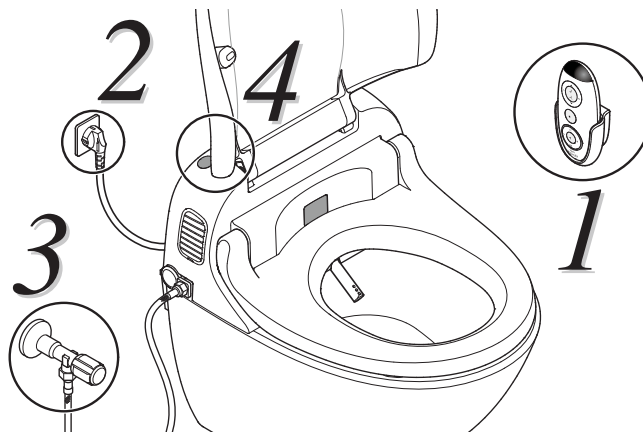

Preparation

1 Put batteries in the remote control. (1)

- (1) Remove the remote control from the remote control holder.
- Grasp the sides of the remote control with both hands and lift straight up.
 - (When fixing the remote control to prevent theft)
 - ▶ See page 12)

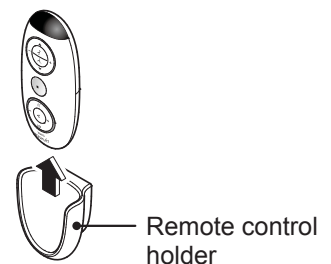

- (2) Open the battery cover on the back of the remote control. (2)(3)(4)
- (3) Insert two AA batteries.
- (4) Close the battery cover.

Tip 1

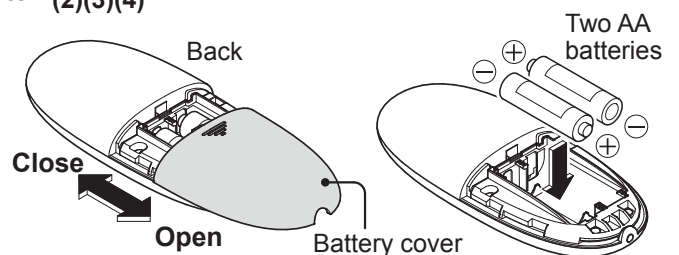

- When the batteries are correctly installed, all lamps on the remote control display area light up for about two seconds.

Remote control display area

All lamps light up (for about 2 seconds)



About the batteries

- Please use alkaline batteries. Observe the following precautions to keep batteries from splitting or leaking.
 - When replacing them, use two new batteries of the same brand.
 - Remove the batteries when not using the remote control for a long time.
 - Do not use rechargeable batteries.

When to change the batteries

If the batteries approach the end of their lifetime, the lamps on the lower half of the remote control display area will blink when a button on the remote control is pressed. (When the water temperature button/seat temperature button is pressed, the set position will be lit at the same time.) Replace the batteries with new ones. Under some conditions such as certain room space, materials or shape of wall and floor, wave receiving may not take place even when lamps on the remote control display area do not blink. In such cases, replace the batteries with new ones.



Blink (Lower half of remote control display area)

Tip 1

- When changing the batteries or cleaning the remote control, turn the  button in the Washlet main operation section off.
- When changing the batteries, timer-based Energy Saver settings might be lost. If this should occur, please reset the settings.

When fixing the remote control to prevent theft

- Loosen the locking attachment screws using a phillips head screw driver, and detach the remote control. Tighten the screws thoroughly when replacing them to fix the attachments in place.
- * When replacing the screws, after they are tight do not try to tighten them more. Doing so could damage the remote control holder or other parts.

1. Loosen the locking attachments using a Phillips head screwdriver.

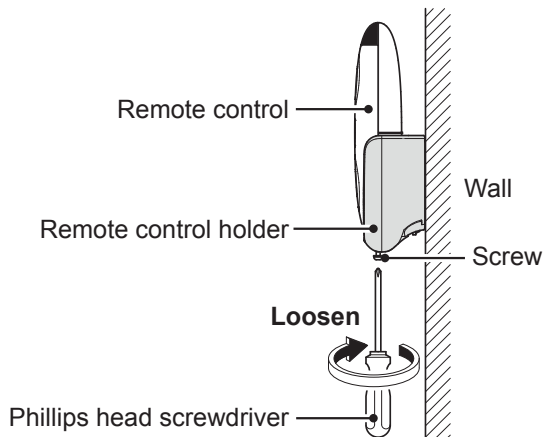

2. Remove the remote control from the remote control holder.

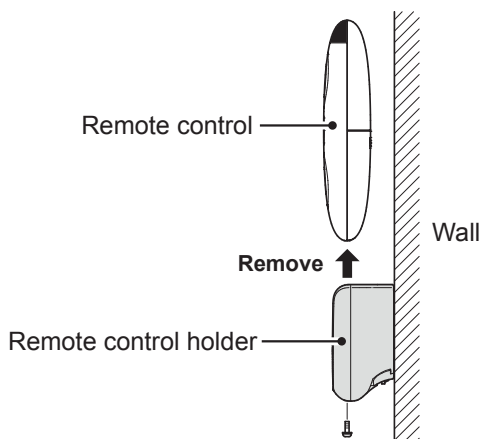

2 Plug the mains plug in to a socket and if there is a switch on the socket, turn on the switch.

- The "POWER" indicator lights automatically.

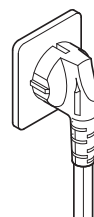

3 Open the water shut-off valve.

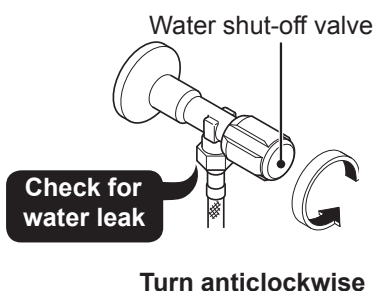

4 Check the Washlet main display section.

- Is the main display section "POWER" indicator lit?

If the "POWER" indicator is not lit, none of the functions can be used.

(Excluding when Energy Saver is in use.)

▶ See page 18)

Press the  button in the Washlet main operation section.

(The "POWER" indicator lights.)

Tip  1

Washlet main display section

"POWER" indicator

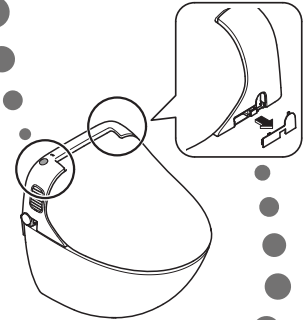
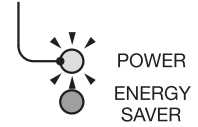

Turning off the power

Press  to turn off the power.

- The "POWER" indicator goes off.

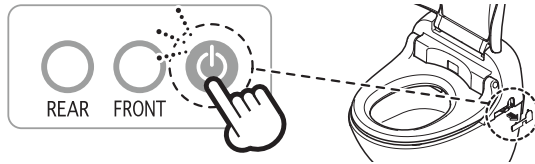

Washlet main operation section

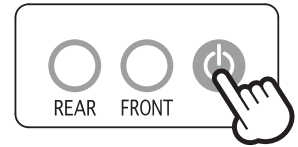

How to use the Washlet

Standard use of the Washlet

1 Sit on the seat.

The seat sensor detects the presence of a person and all the functions become operative.

- The deodorizer starts.
Please test the Power Deodorizer. ▶ See page 17

2 Use and stop the washing functions.

Tip 1

Water pressure adjustment buttons

Use these buttons to adjust the water pressure as you like (there are five levels). Press “+” to increase the water pressure, and “-” to decrease the water pressure.

* Every time you press the REAR or FRONT button, the position is reset to the standard position (3rd step).

To set the preferred water pressure ▶ See page 28

Washing position adjustment buttons

Use these buttons to adjust the washing position as you like (there are five positions). Press “▲” to move the position forward, and “▼” to move the position backward.

* Every time you press the REAR or FRONT button, the position is reset to the standard position (3rd step).

To set a preferred washing position ▶ See page 28

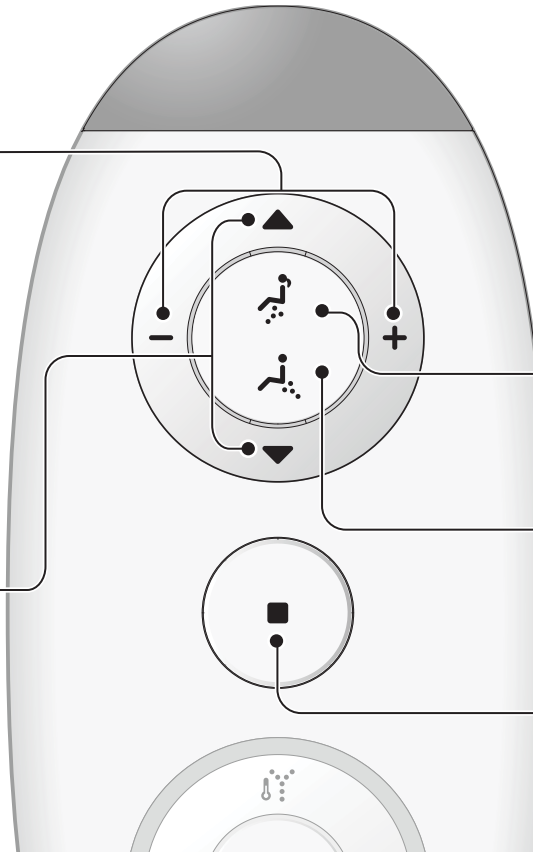

REAR button

Use to wash the rear.

oscillating wash ▶ See below

FRONT button

Use as a bidet.

oscillating wash ▶ See below

STOP button

This button stops rear and front washing.

Other convenient functions

Oscillating wash

This function moves the wand backward and forward to wash thoroughly over a larger area.

(1) Press the  or  button to select.

(2) Press the same button once.

- This starts the oscillating wash.

(3) Press the same button again.

- This stops the oscillating wash.

About the seat sensor

- The seat sensor detects when a person sits down.
- The seat sensor puts out Infrared rays, as shown in the illustration.
- The seat sensor might not work well in some conditions.

▶ See page 34-38

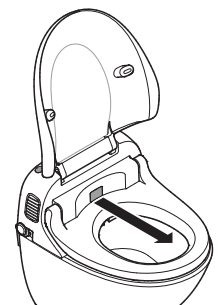

Tip 1

Please sit fully on the seat.

By doing so, the washing position will be more accurate and it is less likely that water will spray out from the Washlet.

3 Stand up from the seat.

The Automatic Power Deodorizer starts.



- It stops after about two minutes.
- Water is emitted from around the wand into the toilet for a few seconds.
- * **Water remaining in the wand is emitted so that fresh water can be used every time.**

Tip  2

Please be aware of these points

- When the Washlet is washing (when the Wand Cleaning is used), water comes out of the left side of the wand. This is necessary for proper functioning and is perfectly normal.
 - * If water continues to come out when the Washlet is not being used for washing, something is probably wrong. Close the water shut-off valve, and contact the installer or seller of this Washlet.
- Water in the warm water tank expands and is sometimes emitted from the right side of the wand.

Using the Washlet if the remote control batteries are dead

- Press the  button or the  button in the main operation section to use the wash function.

(1) Confirm the POWER indicator in the main display section is on.

(2) Press the  or  button to select either rear or front washing.

(3) Press the same button again to stop washing.

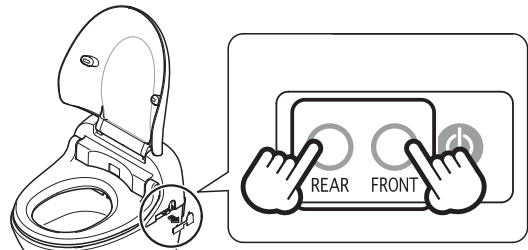

Tip  2

The Automatic Power Deodorizer might not function if the time seated is brief (40 seconds or less).

Convenient functions

Adjusting the temperature

- The temperature of the warm water and the seat can be adjusted with the remote control. Please set them to the temperatures you prefer.

Water Temperature Adjusting

1 Press button.

- The current setting is displayed.

2 Set the desired temperature by pressing the temperature adjustment buttons “+” and “-”.

- The temperature can be set to one of five levels.

Tip  1

- When turning “OFF”, keep pressing the “-” button until the step indication lamp goes out.

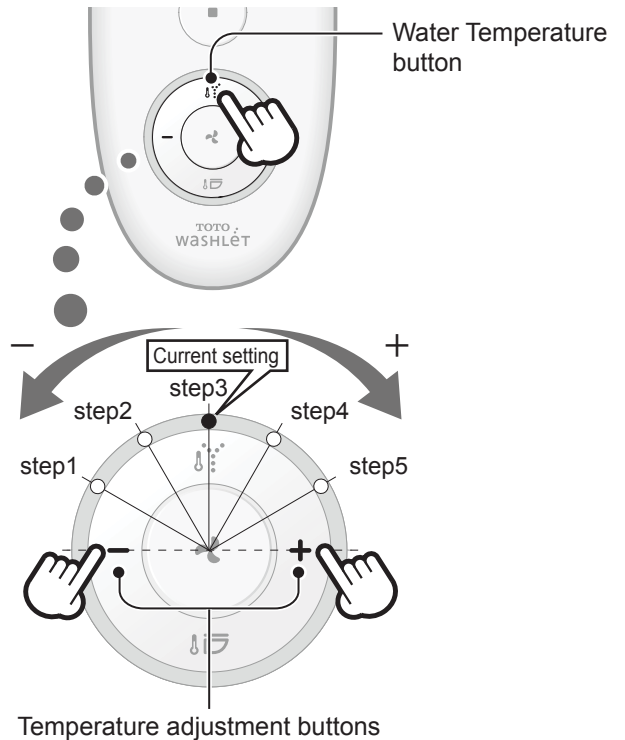

Seat Temperature Adjusting

1 Press button.

- The current setting is displayed.

2 Set the desired temperature by pressing the temperature adjustment buttons “+” and “-”.

- The temperature can be set to one of five levels.

Tip  1

- When turning “OFF”, keep pressing the “-” button until the step indication lamp goes out.

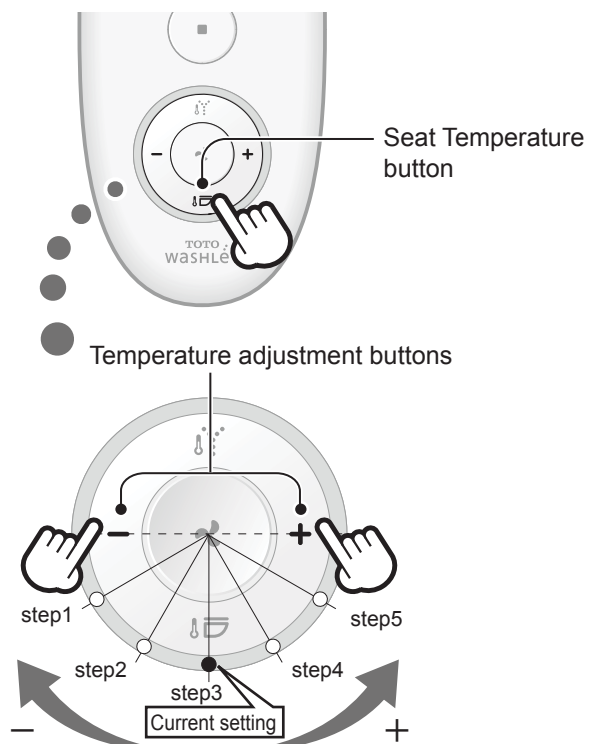

Tip  1

If no button is pressed for more than 5 seconds, the remote control automatically leaves setting mode. If you want to continue changing a setting, start again from the first step.

Using the deodorizer

- The three deodorizer functions include the standard deodorizer, the Power Deodorizer and the Automatic Power Deodorizer.

Using the standard deodorizer and the Automatic Power Deodorizer

The standard deodorizer works when someone sits on the seat.

- When someone gets up off the seat, the Automatic Power Deodorizer works, removing odour from inside the toilet.

1 Sit on the seat.

The standard deodorizer starts.

Tip  2

2 Get up off the seat.

The Automatic Power Deodorizer starts.
It stops automatically after about two minutes

Tip  3

- ▶ See pages 26 and 27 for how to turn off the standard deodorizer or Automatic Power Deodorizer.

Using the Power Deodorizer

Use this function when seated to increase the suction power and remove unwanted odours from the toilet.

Tip  4

1 Press on the remote control.

The Power Deodorizer starts.

To stop the Power Deodorizer

1 Press on the remote control again.

Standard deodorizer power resumes.

Tip  5



Tip  2

The standard deodorizer is set "on" by default.

Tip  3

- The Automatic Power Deodorizer is set "on" by default.
- The Automatic Power Deodorizer might not function if the time seated is brief (40 seconds or less).

Tip  4

The Power Deodorizer will not work if no one is sitting on the toilet. However, the Power Deodorizer button will function for about two minutes after a person gets up off the seat.

Tip  5

If a person stands up without pressing the  button, it will stop automatically after about two minutes.

Energy Saver function

Overview of the Energy Saver timer

- Once the Energy Saver is set, the warm water and seat heaters will turn off at the same time every day to save energy. The duration of the Energy Saver can be set to 3, 6 or 9 hours.

While operating the Washlet

Operates at the set temperatures.

Washlet main display section

Lights (Blue)



While Energy Saver is working

The warm water and seat heaters turn off.

Washlet main display section

Lights (Green)

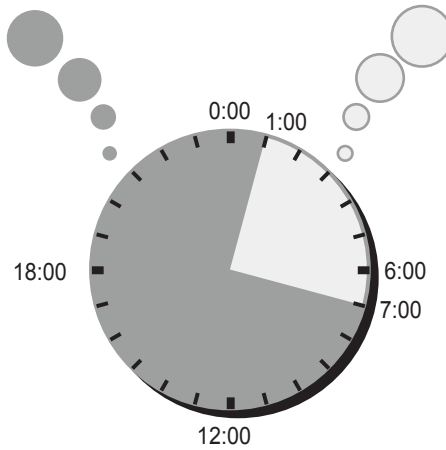

Setting the Energy Saver to turn off from 1 a.m. to 7 a.m. (6 hours)

Using the Energy Saver timer

Conserving energy using the Energy Saver timer

Example: Setting the Energy Saver to turn off from 1 a.m. to 7 a.m. (6 hours)

- At the time that you want the Energy Saver to start every day (1 a.m.), press the  button for at least 5 seconds.

- Hold down until the entire remote control display area blinks.

- Press the temperature adjustment button “+” repeatedly until the lamp blinks in the position as shown in the figure.

Tip  1

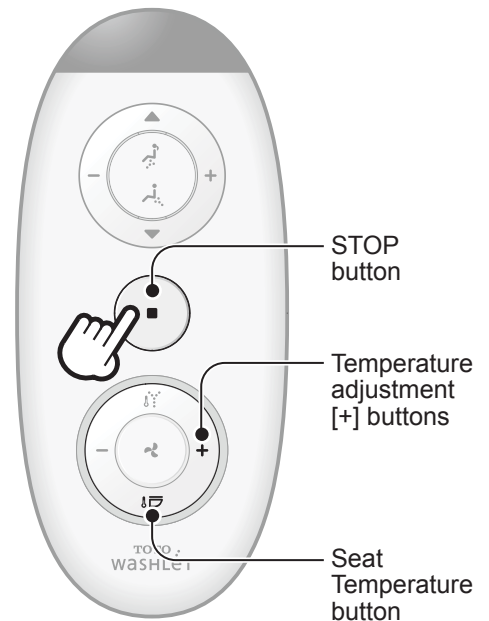
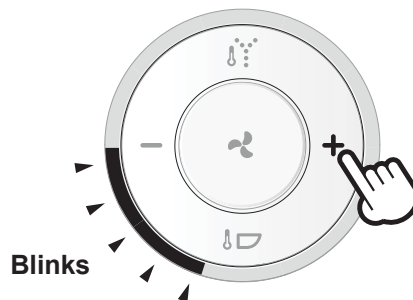

- Press the  button.

The setting change is complete.

Tip  2

Changing the Energy Saver duration, Turning off the Energy Saver timer.

This can be set to 3, 6 or 9.

- To change the energy saving time, reset it to the energy saving start time.

1 Hold the button down for 5 seconds or more.

- Hold down until all lamps on the remote control display area blink

2 Press the Temperature adjustment [+] buttons.

- The indication changes each time it is pressed. Set it to the desired time.
- To cancel the energy saving mode, set it to "OFF".

Tip  1

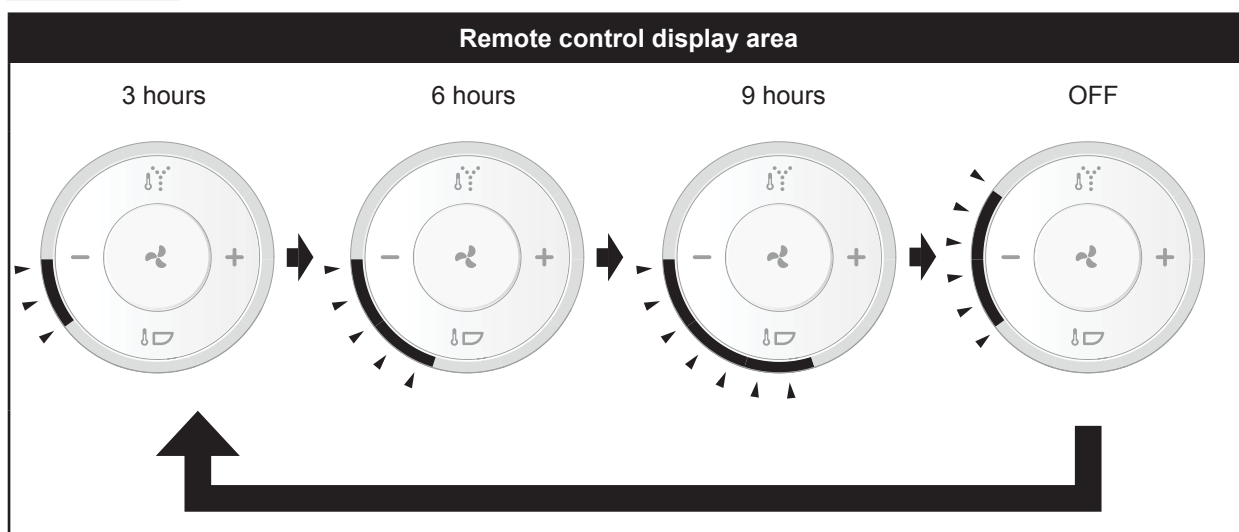

Tip  1

If no button is pressed for more than a minute, the remote control automatically leaves setting mode. If you want to continue changing a setting, start again from the first step.

Tip  2

The heaters can still be used when the Energy Saver timer is working.

- Even when the Energy Saver timer is operative, the warm water and seat heaters will work temporarily when someone sits on the seat.
- It takes about 15 minutes for the seat to warm up.
- It takes about 10 minutes for the water to become warm.

Cleaning the Washlet

Before cleaning

Each part can be detached, allowing thorough cleaning.

Attention!

- Always disconnect the mains plug from the socket when cleaning.
- * Use of the "Wand Cleaning" is an exception to this rule.

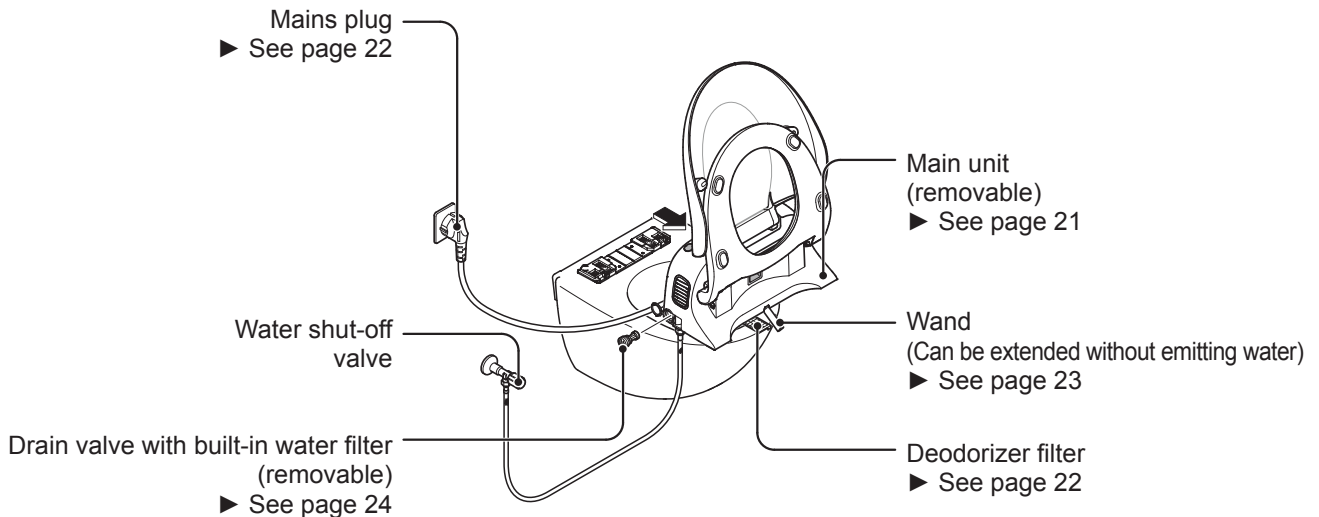

Daily cleaning

Cleaning the main unit, seat and lid

1 Wipe with a soft wet cloth

- After wetting a soft cloth with water, wring it out thoroughly and then use it to wipe the Washlet.

Tip 1

Cleaning when the Washlet is very dirty

- (1) Wipe with a soft cloth dampened with diluted kitchen cleanser (pH neutral).
- (2) After cleaning with the cleanser, wipe again with clean water.

Wipe away any toilet cleanser that spills on the Washlet

- After wiping with a soft cloth dampened with water, wipe away any remaining droplets.

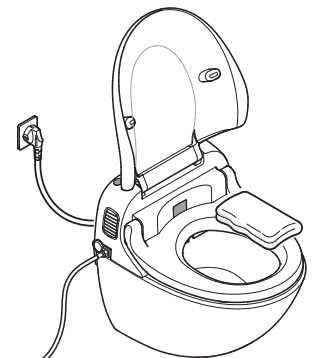

Attention!

When cleaning inside the toilet with cleanser

- When cleaning inside the toilet with toilet cleanser, disinfectant or similar substances, flush away the cleaning substances as quickly as possible (within three minutes), and then leave the seat and lid open. In addition, be sure to completely remove any cleanser remaining on the toilet. (If vapours from toilet cleansers or similar substances enter the main Washlet unit, this could lead to malfunction.)

Tip 1

- Since the Washlet is made of plastic, do not wipe it with a dry cloth, toilet paper or any similar material. Doing so could cause scratches.
- The Washlet is an electric appliance, so be very careful to avoid letting water get inside it. Thoroughly wipe away any cleanser left in gaps between the main unit and the toilet.

Do not forget to clean the seat sensor and remote control transmission section!

If these parts become dirty various Washlet functions might stop working.

- ▶ See pages 9, 10, 14 and 34-38

Thorough cleaning

Cleaning between the main Washlet unit and the toilet

- About once a month, remove the main Washlet unit to clean the top of the toilet and the bottom of the main unit.

1 Disconnect the mains plug

- * For your safety, disconnect the mains plug before removing the main unit. In addition, avoid splashing water on the disconnected mains plug.

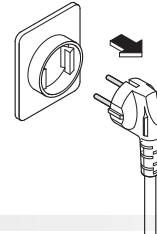

2 Remove the main Washlet unit.

- While pressing the Washlet release button on the right side, pull the main Washlet unit forward.
- * When the main Washlet unit is detached, do not turn it over or tip it at a great angle.
- * Do not pull the unit with a lot of force because the water supply hose and power cord are attached to it.

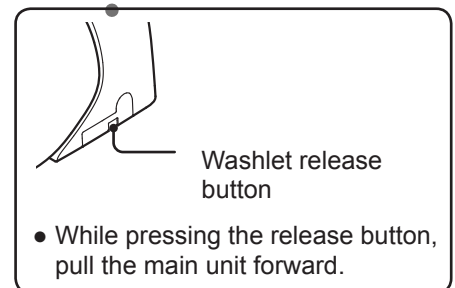
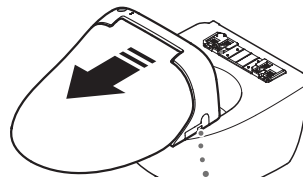

3 Clean the unit.

- ▶ To clean these parts, follow the instructions in "Daily cleaning" on page 20.

4 Reattach the main Washlet unit.

- (1) Align the centre of the main Washlet unit and the centre of the base plate.
 - (2) Slide the main Washlet unit over the top of the toilet to cover the base plate completely, until you hear a click.
- * If the main Washlet unit is not pushed completely onto the base plate, the Washlet will not function.

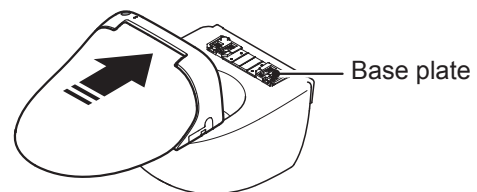

5 Reconnect the mains plug.

Periodic cleaning

Cleaning the mains plug

- Clean the mains plug about once per month.

1 Disconnect the mains plug.

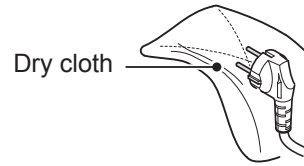

2 Clean the plug.

- Remove dust from the blades and other parts of the mains plug with a dry cloth.

3 Reinsert the mains plug.

- Insert the plug completely.

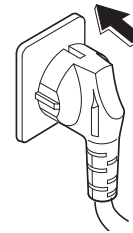

Cleaning the deodorizer filter

- If the deodorizer does not seem to be clearing unpleasant smells, clean the deodorizer filter.

1 Disconnect the mains plug.

2 Grasp the deodorizer filter handle and pull it forward.

- The deodorizer filter cannot be disconnected. Do not pull it with excessive force. (Doing so could cause damage or malfunction.)

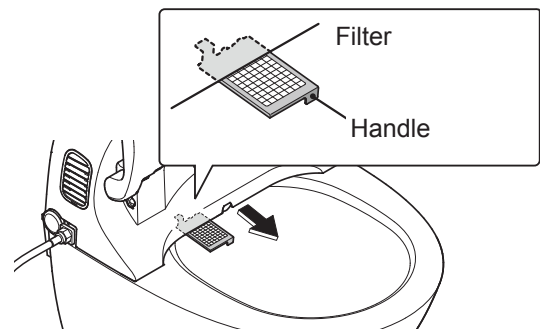

3 Clean the filter.

- Remove the debris on the filter with a toothbrush or similar tool.

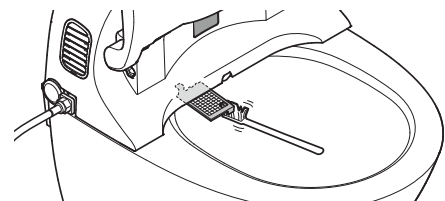

4 Push the deodorizer filter back in.

- Push the filter in completely until you hear a click.

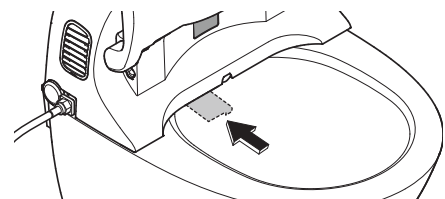

5 Reconnect the mains plug.

Cleaning the wand

- The wand can be extended without emitting water, making it easy to clean.

1 Press the  button for at least 5 seconds.

The wand extends.

- The wand automatically returns to its inactive position after about 5 minutes.

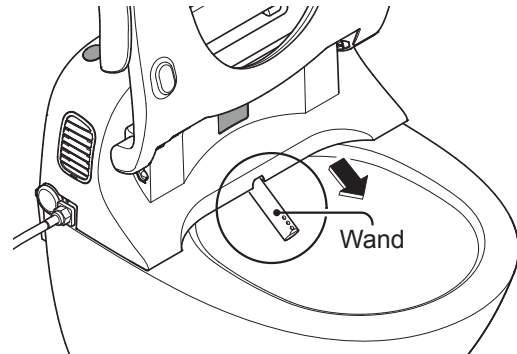
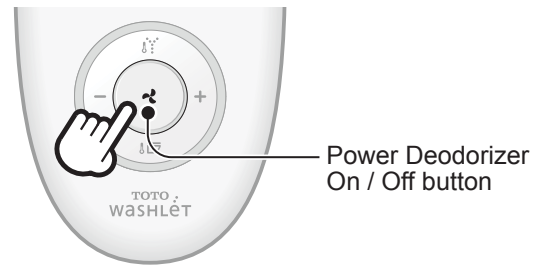

2 Clean the wand.

- Wipe the wand with a soft damp cloth.
- * Do not push or pull the wand with excessive force. (This could cause damage or malfunction.)

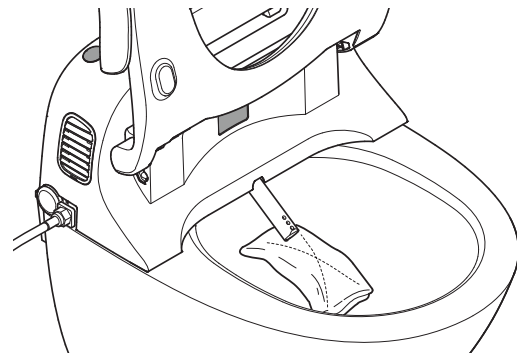

3 Press the  button.

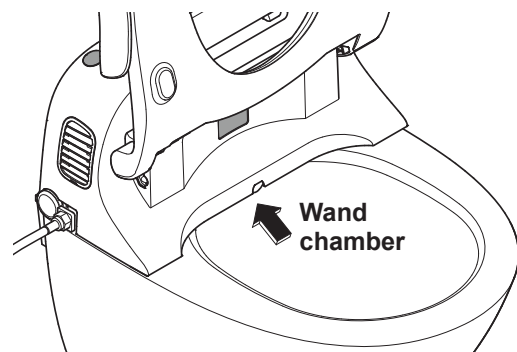

The wand retracts and automatically to clean itself.



Cleaning the water supply filter



- Clean the water supply filter if the water pressure during rear or front washing seems to have weakened.

1 Close the water shut-off valve and stop the water supply

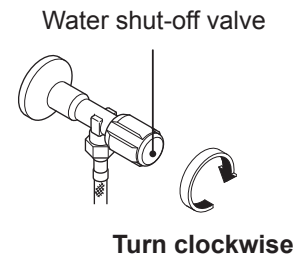
 CAUTION	
 Prohibited	Do not detach the drain valve with built-in water filter while the water shut-off valve is still open. <ul style="list-style-type: none">• Doing so will cause water to spill.



2 Drain the water from the Washlet pipes.

- (1) Press the  button for at least 5 second on the remote control.
(This drains any remaining water from the Washlet.)
- (2) Press the  button.
(The wand returns to its inactive position.)



3 Open the cap.

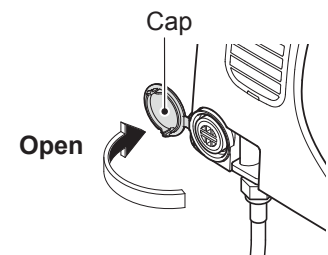

4 Detach the drain valve with built-in water filter

- Use a flat-blade screwdriver to loosen the drain valve with built-in water filter and pull it out.

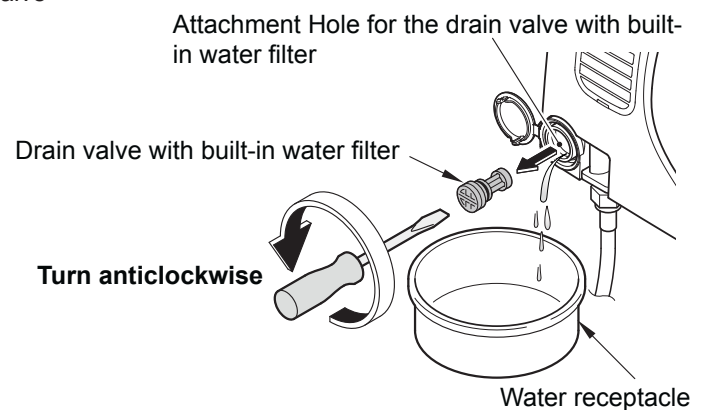

5 Clean the filter.

- Wash off and remove debris caught in the water filter mesh.

Tip  1

- * Thoroughly remove the debris on the filter with a toothbrush or similar tool.
- * Use a cotton swab or similar to remove debris from inside the attachment hole for the drain valve with built-in water filter.

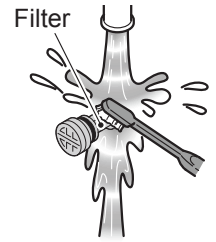

6 Reattach the drain valve with built-in water filter.

- Insert the drain valve with built-in water filter and use a flat-blade screwdriver to tighten it thoroughly.

 CAUTION



Required

Thoroughly tighten the drain valve with built-in water filter.

- Failure to do so could cause a water leak.

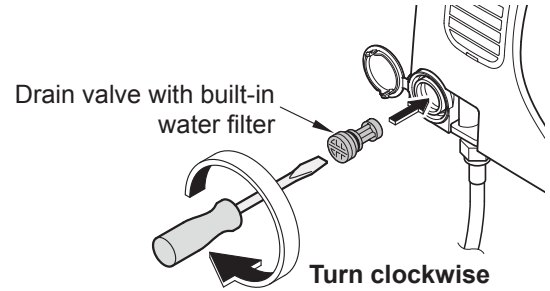

7 Open the water shut-off valve.

- Open the water shut-off valve.
- * Confirm that no water is leaking from the plumbing, the main Washlet unit or the drain valve with built-in water filter.

Water shut-off valve

A line drawing of a water shut-off valve with a handle. A curved arrow indicates the handle is being turned anticlockwise. A callout box contains the text "Check for water leak".

Turn anticlockwise

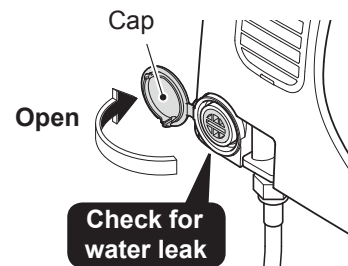

8 Close the cap.

Tip  1

Cleaning the water supply filter

- Do not use cleanser. Wash with plain water.
- Do not break the water supply filter or detach it from the drain valve.

Changing settings

Before changing other settings, follow the instructions in the next section, “Setting whether or not the remote control makes sound” to turn the sound on if it is currently off. You will use this sound to confirm changes to other settings.

Setting whether or not the remote control makes sound

- By default, when you press a remote control button, you will hear a sound when the main Washlet unit receives the signal.
- You can choose to turn this confirmation sound off.

Default setting: Sound on

1 Press for at least 10 seconds.

- Hold the button down until the whole remote control display blinks.

2 Press button.

Tip  1

- The setting changes every time the button is pressed.

To turn the sound ON

Press the button until you hear a short beep.

To turn the sound OFF

Press the button until you hear a long beep.

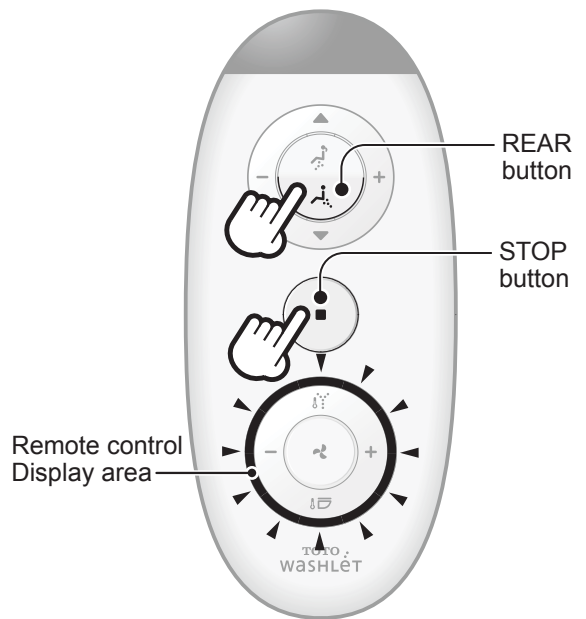

3 Press the button again.

This completes the change to the settings.

Setting operation of the standard deodorizer

- You can set whether or not the standard deodorizer works automatically.

Default setting: ON

1 Press for at least 10 seconds.

- Hold the button down until the whole remote control display blinks.

2 Press the button.

Tip  2

- Each time you press this, the setting changes between ON and OFF.

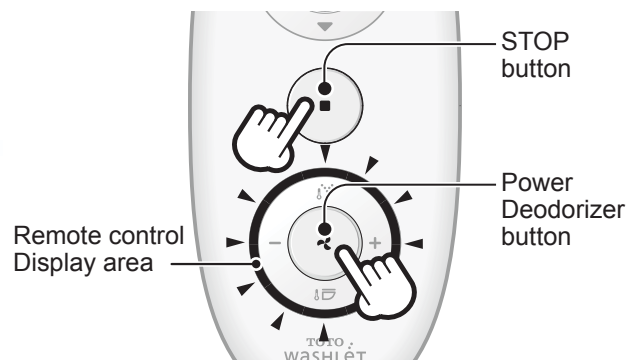

Tip  1,2

If no button is pressed for more than a minute, the remote control automatically leaves setting mode. If you want to continue changing a setting, start again from the first step.

To turn automatic operation of the standard deodorizer ON

Press the button until you hear a short beep.

To turn automatic operation of the standard deodorizer OFF

Press the button until you hear a long beep.

3 Press the button again.

This completes the change to the settings.

Making the Power Deodorizer work automatically

Automatic Power Deodorizer

Default setting: ON

1 Press for at least 10 seconds.

- Hold the button down until the whole remote control display blinks.

2 Press Temperature adjustment “-” buttons.

Tip  3

- Each time you press this, the setting changes between ON and OFF.

To turn automatic operation of the Power Deodorizer ON

Press the button until you hear a short beep.

To turn automatic operation of the Power Deodorizer OFF

Press the button until you hear a long beep.

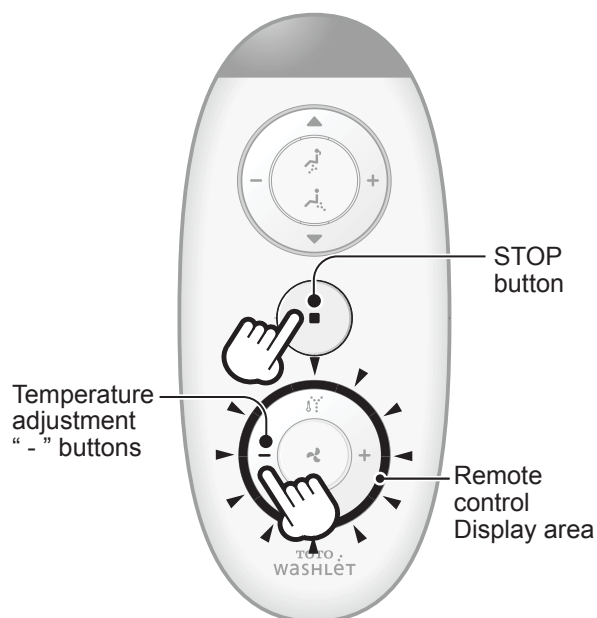

3 Press the button again.

This completes the change to the settings.

Water pressure and washing position

The unit can be set to remember the last water pressure and washing positions used.

1 Press  for at least 10 seconds.

- Hold the button down until the whole remote control display blinks.

2 Press  for at least 5 seconds.

Tip  4

3 Press the  button again.

This completes the change to the settings.

- To restore the previous settings, repeat the above procedures.

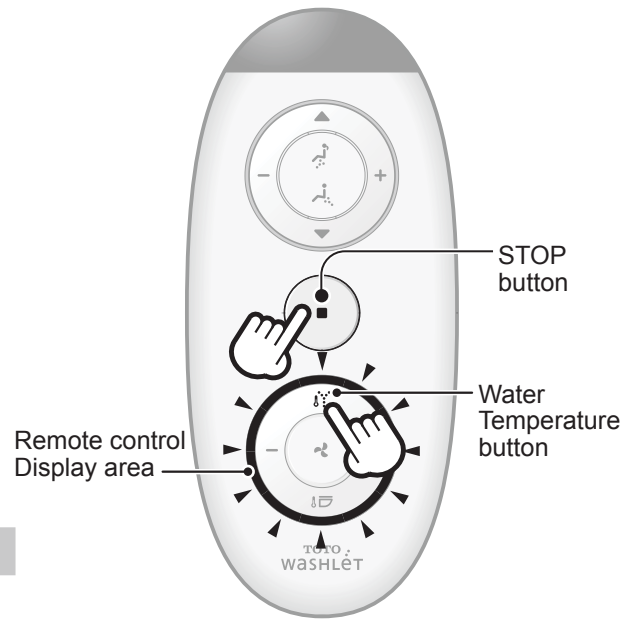

Tip  4

If no button is pressed for more than a minute, the remote control automatically leaves setting mode. If you want to continue changing a setting, start again from the first step.

Preventing damage from freezing and measures for long-term disuse

Preparation for freezing conditions

Tip 1



Keep the toilet warm, so that the temperature stays above freezing. If this is not possible, drain the water. If you worry that the water might freeze, follow these procedures to prevent damage to the Washlet. If the Washlet freezes, it might suffer damage and water leaks could occur.

Draining the water

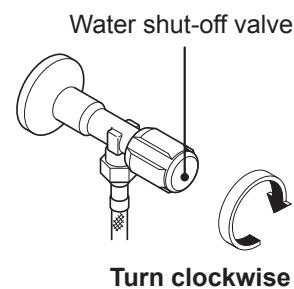

- 1 Close the water shut-off valve and stop the water supply.

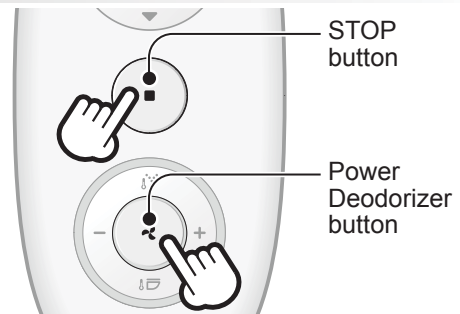

- 2 Drain the water from the Washlet pipes.

- (1) Press the  button for at least 5 seconds on the remote control.
(This drains any remaining water from the Washlet.)
- (2) Press the  button.
(The wand returns to its inactive position.)
- (3) Use a flat-blade screwdriver to loosen the drain valve with built-in water filter and then pull it out.



	CAUTION
	Do not detach the drain valve with built-in water filter while the water shut-off valve is still open. <ul style="list-style-type: none">• Doing so will cause water to spill.

Prohibited

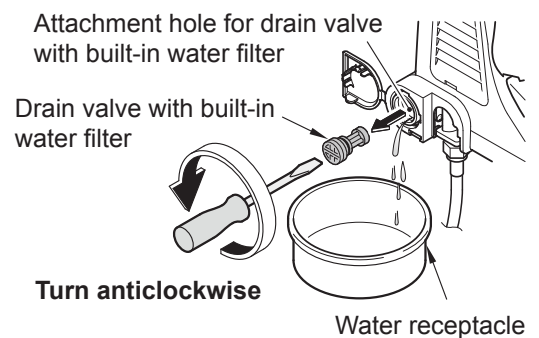

Tip 1

If you expect freezing temperatures

Do not use the Energy Saver, because the Washlet could be damaged if the water freezes when the heaters are turned off.

► See page 17 for how to turn off the Energy Saver

(4) Lift the water supply hose to drain the water out of it.

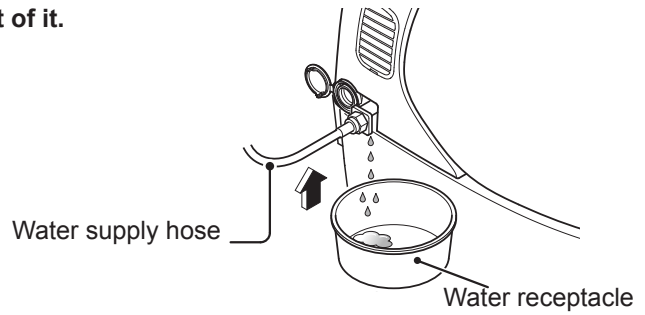

3 Reattach the drain valve with built-in water filter.

- Insert the drain valve with built-in water filter and use a flat-blade screwdriver to tighten it thoroughly.

	CAUTION
	Thoroughly tighten the drain valve with built-in water filter.
Required	<ul style="list-style-type: none">• Failure to do so could cause a water leak.

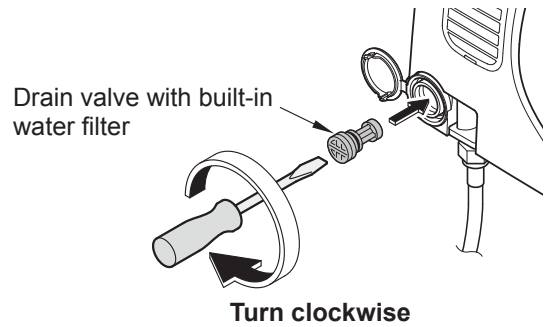

4 Keep the inside of the main Washlet unit warm.

(1) Confirm that the button in the main operation section is “on” and use the remote control to set high warm water and seat temperature levels.

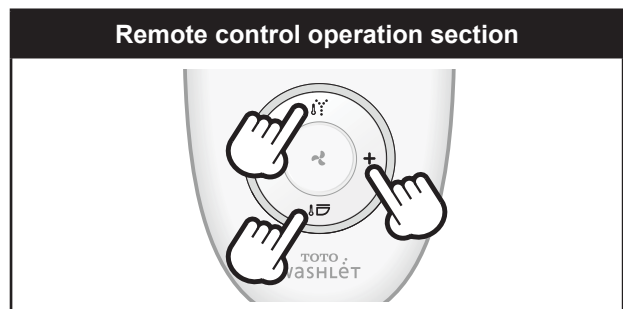
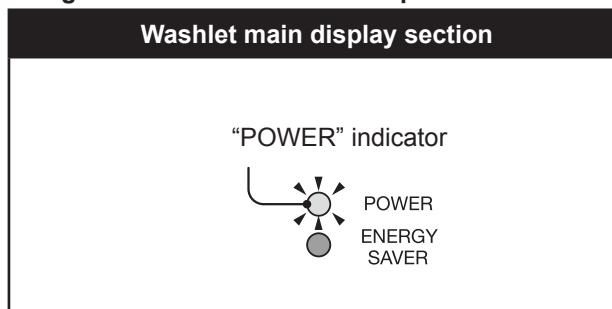

(2) Close the lid.

What to do if you will not use the Washlet for a long time

- If the Washlet is not used for a long time, water left in it could become contaminated and cause skin inflammation or other problems. You should also drain the water to prevent the Washlet from freezing.

Tip  1

Draining the water

- 1 Close the water shut-off valve and stop the water supply.**

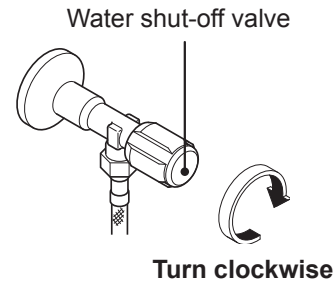

- 2 Drain the water from the Washlet pipes.**

► See step 2 of “Draining the water” on page 29.

- 3 Disconnect the mains plug.**

* For your safety, disconnect the mains plug before removing the main unit. In addition, avoid splashing water on the disconnected mains plug.

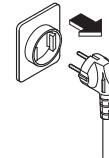

- 4 Remove the main Washlet unit.**

- While pressing the Washlet release button on the right side, pull the main Washlet unit forward.
- Rest the detached Washlet on the front half of the top of the toilet.
- * When the main Washlet unit is detached, do not turn it over or tip it at a great angle.
- * Do not pull the unit with a lot of force because the water supply hose and power cord are attached to it.

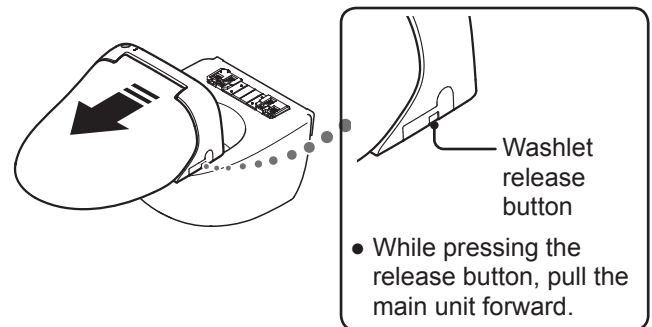

- 5 Open the cover.**

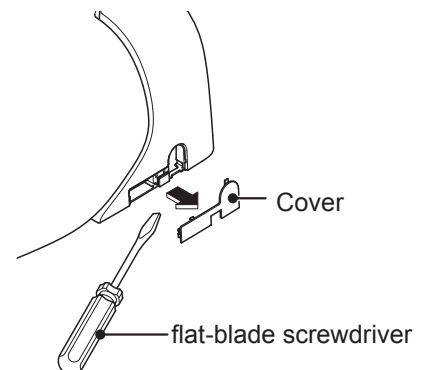

Tip  1

Do not forget to drain the water!

Always drain the water to prevent freezing:

- When leaving home for a long time in the winter.
- When the Washlet is installed in a vacation home or other location that is not always occupied. Empty homes can be very cold in winter.

6 Remove the water drainage plug and drain the water from the main Washlet unit.

- Use a flat-blade screwdriver to loosen the water drainage plug and then pull it forward.
- About 700 ml of water will pour out of the drainage opening.

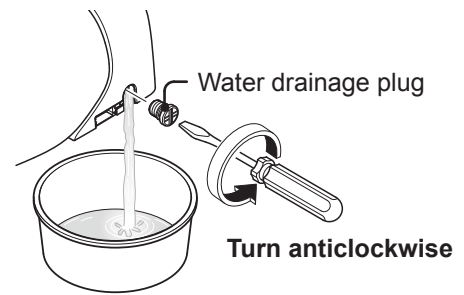

7 Reinsert the water drainage plug.

8 Reattach the cover.

9 Reattach main Washlet unit.

- (1) Align the centre of the main Washlet unit and the centre of the base plate.
 - (2) Slide the main Washlet unit over the top of the toilet to cover the base plate completely, until you hear a click.
- * If the main Washlet unit is not pushed completely onto the base plate, the Washlet will not function.

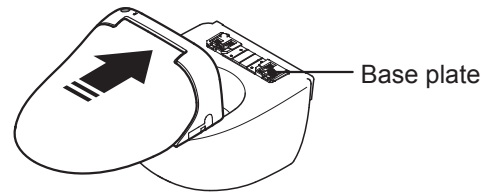

10 Put antifreeze in the toilet.

Tip  2

Tip  2

Put antifreeze in the water remaining in the toilet to reduce the chance of freezing.

Restoring the water supply after draining the Washlet

1 Open the water shut-off valve.

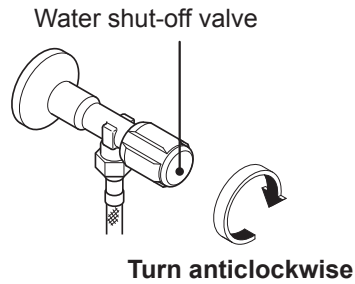

- Check that there are no leaks in the plumbing or the main Washlet unit.



2 Insert the mains plug in the socket.

3 Run water through the wand.

Tip 1

- Cover the seat sensor with white paper and press the  or  button to make water flow through the wand for about 2 minutes.
(It takes about one minute to discharge the water from the wand. Catch the water in a cup.)

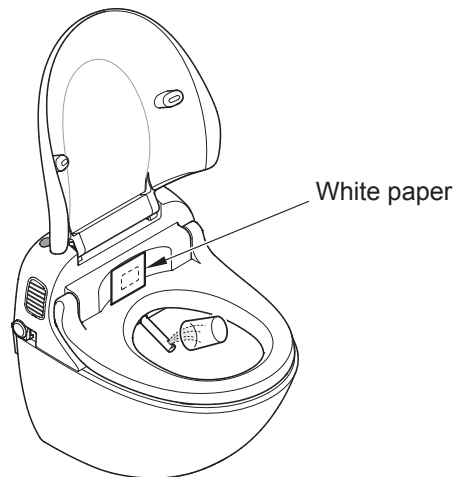

Tip 1

What to do if the remaining water has frozen and no water comes out

Water left in the water supply hose and water shut-off valve might freeze. If this has happened, warm the inside of the toilet and use a cloth soaked in warm water to warm the water supply hose and water shut-off valve.

Troubleshooting

Please read this section to troubleshoot any problem before requesting repairs. If you still cannot solve the problem after reviewing this section, please contact TOTO Europe GmbH (see the back cover for contact information).

CAUTION

If a water leak occurs, close the water shut-off valve to stop the water supply.



Required

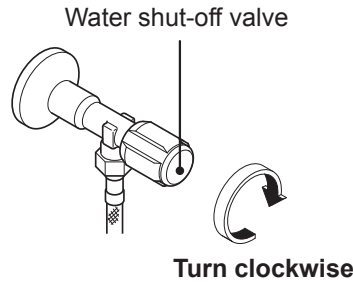

Please confirm the following three points before requesting repair.

(1) Is the main Washlet unit attached correctly to the base plate?

- Are the Washlet and base plate out of alignment?
→ Remove the main Washlet unit and reattach it to the base plate once. ▶ See page 21

(2) Is the Washlet “POWER” indicator in the main display section lit?

- Is the “POWER” indicator lit? ▶ See page 12
→ If the “POWER” indicator is lit, go to step (3).
→ If the “POWER” indicator is not lit
 - Is the “ENERGY SAVER” indicator lit?
→ The Energy Saver timer might be on. ▶ See page 18
 - Are all indicators unlit?
→ Follow these steps to see if the indicators light.

◆ Check here

Washlet main display section

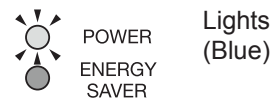

1. Press the  button in the main operation section.
2. Has there been a power cut or are any of the central power breakers switched off? If there is a power cut wait until the power comes back on. If the breaker controlling the power to the Washlet is off, turn it back on.

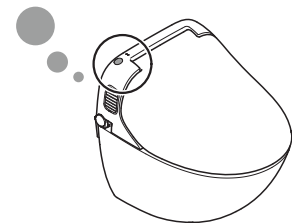

(3) Is the remote control working?

- Do the lamps on the lower half of the remote control display area blink when a button on the remote control is pressed?
→ If so, the batteries are running out of power. Install new batteries. ▶ See page 11
- Is the remote control signal transmission area covered or dirtied by debris or water droplets, for example?
→ Remove or clean whatever is blocking the transmission area.
▶ See pages 9 and 10







If the problem is not resolved after confirming (1), (2) and (3), continue with “Identifying the problem” on the next page.

Identifying the problem

Do rear and front washing work?

Trouble

Washing functions do not work when the REAR and FRONT buttons on the remote control are pressed.

Tests and results		Solutions
<p>Does the function work when the  or  button in the Washlet main operation section is pressed?</p> <p>* If the seat sensor does not detect a person, these functions will not work. Please sit on the seat when confirming these operations.</p>	<p>If it works</p> <ul style="list-style-type: none"> The remote control signal might not be being received. 	<ul style="list-style-type: none"> Follow the instructions in "(3) Is the remote control working?" to check whether it is working. ▶ See page 34 Remove or clean whatever is blocking it. ▶ See pages 9 and 14 Sit on the seat fully and raise clothing so that the sensor can detect skin.
	<p>If it does not work</p> <ul style="list-style-type: none"> Is the seat sensor covered or dirtied by debris or water droplets, for example? 	
	<p>If it does not work</p> <ul style="list-style-type: none"> The seat sensor might not work depending on how a person sits or the colour and fabric of their clothing. 	
<p>Does the wand extend when you press the  or  button on the remote control?</p>	<p>If the wand extends but washing water does not come out or is very weak</p> <ul style="list-style-type: none"> Water might not be supplied to the Washlet, or debris could be blocking the wand. 	<ul style="list-style-type: none"> Is the water cut off? Press  and wait for the water to turn on again. Is the water shut-off valve closed? Turn the water shut-off valve anticlockwise. ▶ See page 12 Clean the drain valve with built-in water filter. ▶ See page 24 If someone has been sitting on the seat continuously for about 2 hours or longer, rear and front washing functions will stop working. Get up off the seat and then sit down again. If the seat sensor is covered or dirtied by debris or water droplets, for example, the sensor might constantly sense something. Remove or clean whatever is blocking it. ▶ See pages 9 and 14 If a seat or lid cover is left on the Washlet, the seat sensor might constantly sense something, so remove any such cover. Wait until the indicator in the Washlet main display section lights and press the button again.
	<p>If the wand does not extend</p> <ul style="list-style-type: none"> Have you been sitting on the seat for about 2 hours or longer? 	
	<p>If the wand does not extend</p> <ul style="list-style-type: none"> Is the seat sensor constantly sensing something? 	
	<p>If the wand does not extend</p> <ul style="list-style-type: none"> Have you been using it continuously? Rear and front washing stop automatically about 5 minutes after pressing the button. The indicator in the Washlet main display section blinks for about a minute while water is being warmed. 	

Do the deodorizer and Energy Saver work?

Trouble

The deodorizer does not function.

Tests and results		Solutions
<p>Can you hear the sound of the deodorizer when you sit on the seat?</p>	<p>If there is no deodorizer sound</p> <ul style="list-style-type: none"> Is the seat sensor covered or dirtied by debris or water droplets, for example? 	<ul style="list-style-type: none"> Remove or clean whatever is blocking it. ▶ See pages 9 and 14

Do the deodorizer and Energy Saver work?

Trouble The deodorizer does not function.

Tests and results		Solutions
Can you hear the sound of the deodorizer when you sit on the seat?	If there is no deodorizer sound <ul style="list-style-type: none"> The seat sensor might not work depending on how a person sits or the colour and fabric of their clothing. 	<ul style="list-style-type: none"> Sit on the seat fully and raise clothing so that the sensor can detect skin.
	If there is no deodorizer sound <ul style="list-style-type: none"> Is the deodorizer set to "off"? 	<ul style="list-style-type: none"> Set the deodorizer to "on". <ul style="list-style-type: none"> ▶ See page 26
	If there is deodorizer sound <ul style="list-style-type: none"> Is the deodorizer filter blocked? 	<ul style="list-style-type: none"> Clean the deodorizer filter. <ul style="list-style-type: none"> ▶ See page 22

Trouble The Automatic Power Deodorizer does not work.

Tests and results	Solutions
Is the Automatic Power Deodorizer set to "off" on the remote control?	<ul style="list-style-type: none"> Set the Automatic Power Deodorizer to "on". <ul style="list-style-type: none"> ▶ See page 27

Trouble The Energy Saver timer is not working.

Tests and results	Solutions
Have you changed the batteries in the remote control?	<p>If you changed the batteries in the remote control, or the batteries have gone dead, these settings might be lost.</p> <ul style="list-style-type: none"> Set the Energy Saver timer settings again. <ul style="list-style-type: none"> ▶ See pages 18 and 19

The seat or washing temperature is cold

Trouble The seat does not warm up (it is cold).

Tests and results	Solutions
Check the indications on the remote control display.	<p>Is the seat temperature setting low or off?</p> <ul style="list-style-type: none"> Press the  button on the remote control and make adjustments using the temperature adjustment buttons “+” and “-”. ▶ See page 16
Is the main Washlet unit "ENERGY SAVER" indicator lit?	<p>If the green "ENERGY SAVER" indicator is lit</p> <ul style="list-style-type: none"> The Energy Saver timer, which automatically turns the seat heater off, is active. <ul style="list-style-type: none"> Sitting on the seat temporarily starts the heater. It will become warm in about 15 minutes. <ul style="list-style-type: none"> ▶ See page 18
Have you been sitting on the seat for an hour or more?	<ul style="list-style-type: none"> If someone sits on the seat continuously for an hour or more, the seat heater will turn off. Get up off the seat to restart the seat heater automatically.
Is the seat sensor covered or dirtied by debris or water droplets, for example?	<ul style="list-style-type: none"> Remove or clean whatever is blocking it. <ul style="list-style-type: none"> ▶ See pages 9 and 14

The seat or washing temperature is cold

Trouble The rear or front washing water is cold.

Tests and results		Solutions
Check the indications on the remote control display.	Is the water temperature setting low or off?	<ul style="list-style-type: none"> Press the  button on the remote control and make adjustments using the temperature adjustment buttons “+” and “-”. ▶ See page 16
Is the Energy Saver timer on?		<ul style="list-style-type: none"> Sit on the seat and wait for about 10 minutes.

The rear and front washing water pressure is weak

Trouble The washing water pressure is weak.

Tests and results		Solutions
Check the indications on the remote control display.	Is the water pressure set to a low level?	<ul style="list-style-type: none"> Press the “+” water pressure adjustment button on the remote control. ▶ See page 14
Is the water filter in the drain valve blocked?		<ul style="list-style-type: none"> Clean the built-in water filter. ▶ See page 24
Is the water shut-off valve closed?		<ul style="list-style-type: none"> Turn the water shut-off valve anticlockwise to open it. ▶ See page 12

Rear or front washing starts and stops on its own

Trouble Rear or front washing suddenly stops during use.

Tests and results		Solutions
Have you been using it for a long time?	Rear and front washing stop automatically about 5 minutes after pressing the button. The indicator in the Washlet main display section blinks for about a minute while water is being warmed.	<ul style="list-style-type: none"> Wait until the indicator in the Washlet main display section lights and press the button again.
Are you sitting in a way that prevents the seat sensor from working?	If you get up slightly from the seat, or sit forward on the seat, the seat sensor might temporarily stop working.	<ul style="list-style-type: none"> Sit fully on the seat.

Trouble Water comes out of the wand when it should not.

Tests and results		Solutions
Does water come out of the left side of the wand even when no one is on the seat?	The seat sensor could be falsely detecting a person in the following circumstances, for example: <ul style="list-style-type: none"> When using a washbasin near the toilet When cleaning the unit 	—
After getting up off the seat, water is emitted from around the wand into the toilet for a few seconds.		—
Is water coming out of the base of the wand?	Sometime water comes out of the base of the wand during washing. This is a necessary function.	<ul style="list-style-type: none"> If water is coming out continuously when not washing, this could be a malfunction. Close the water shut-off valve and contact the installing or selling business.

Rear or front washing starts and stops on its own

Trouble Water comes out of the wand when it should not.

Tests and results

Solutions

Is water coming from the right side of the wand?

The water inside the warm water tank expands and comes out. This is normal.

—

The deodorizer functions when it should not

Trouble The deodorizer functions when it should not.

Tests and results

Solutions

The seat sensor could be falsely detecting a person and causing the deodorizer to function in the following circumstances, for example:

- When using a washbasin near the toilet
- When cleaning the unit
- When opening/closing the seat or toilet lid manually

—

Trouble The deodorizer sound becomes louder when you get up from the seat.

Tests and results

Solutions

Is the Automatic Power Deodorizer on?

This louder sound is from the Automatic Power Deodorizer.

—

Other situations

Trouble Water is leaking from the plumbing connections.

Tests and results

Solutions

Is a plumbing connection nut loose?

- Use a monkey wrench or similar tool to tighten the loose part more.
- * If the water leak does not stop, close the water shut-off valve and request repair work.
- ▶ See page 34

Trouble The main Washlet unit feels loose.

Tests and results

Solutions

Are the bolts in the base plate that fixes the main Washlet unit to the toilet loose?

- Align the base plate with the mounting position label and thoroughly retighten the bolts.

Trouble The toilet seat and lid close more quickly when covers are attached.

Tests and results

Solutions

The weight of a cover will make it close more quickly.

—

Trouble The speed that the toilet seat and lid close changes between summer and winter.

Tests and results

Solutions

The speed might be changed some due to the room temperature or frequency of use.

—

Specifications

Rated power		220–240 V AC, 50 Hz	
Rated power consumption		274–319 W	
Standard power consumption per year *		190 (261) kWh/year	
Power cord length		1.0 m	
Washlet equipment	Spray volume	Rear wash	About 0.29–0.55 L/min (at 0.2 MPa water pressure)
		Front wash	About 0.27–0.55 L/min (at 0.2 MPa water pressure)
	Spray temperature		About 30–40°C
	Heater capacity		190–230 W
	Safety equipment		Temperature fuse, excessive heating prevention device, float switch to prevent heating when empty
Backflow prevention equipment		Vacuum breaker, reverse flow stopping valve, air gap	
Deodorizer equipment	Type	O ₂ deodorizer	
	Airflow	Standard mode: about 0.09 m ³ /min Power mode: about 0.16 m ³ /min	
Heated seat	Surface temperature	Temperature adjustment range : about 28–35°C	
	Heater capacity	47–56 W	
	Safety equipment	Temperature fuse	
Water pressure		0.1–1.0 MPa	
Water temperature		0–35°C	
Operating ambient temperature		0–40°C	
Dimensions		439 mm (width), 538 mm (depth), 205 mm (height)	
Weight		About 9.0 kg	

* Standard power consumption per year without the energy saver functions is shown in the brackets.



Warranty

LIMITED TWO YEARS WARRANTY

1. TOTO warrants its products to be free from manufacturing defects under normal use and service for a period of two (2) years from the date of purchase. This warranty is extended only to the ORIGINAL PURCHASER.
2. TOTO's obligations under this warranty are limited to repair or replacement, at TOTO's option, of products or parts found to be defective, provided that such products were properly installed and used in accordance with this OWNER'S MANUAL. TOTO reserves the right to make such inspections as may be necessary to determine the cause of the defect. TOTO will not charge for labor or parts in connection with warranty repairs or replacements.
TOTO is not responsible for the cost of removal, return and/or reinstallation of products.
3. This warranty does not apply to the following items:
 - a) Damage or loss sustained in a natural calamity such as fire, earthquake, flood, thunder, electrical storm, etc.
 - b) Damage or loss resulting from any unreasonable use, misuse, abuse, negligence, or improper maintenance of the product.
 - c) Damage or loss resulting from removal, improper repair, or modification of the product.
 - d) Damage or loss resulting from sediments or foreign matter contained in a water system.
 - e) Damage or loss resulting from improper installation or from installation of a unit in a harsh and/or hazardous environment.
4. This warranty gives you specific legal rights. You may have other rights which vary from country to country.
5. To obtain warranty repair service under this warranty, you must take the product or deliver it prepaid to a TOTO service facility, together with a letter stating the problem, or contact a TOTO distributor or product service contractor, or directly to TOTO sales office. If, because of the size of the product or nature of the defect, the product can not be returned to TOTO, receipt by TOTO of written notice of the defect shall constitute delivery. In such case, TOTO may choose to repair the product at the purchaser's location or pay to transport the product to a service facility.

THIS WRITTEN WARRANTY IS THE ONLY WARRANTY MADE BY TOTO. REPAIR OR REPLACEMENT AS PROVIDED UNDER THIS WARRANTY SHALL BE THE EXCLUSIVE REMEDY AVAILABLE TO THE PURCHASER. TOTO SHALL NOT BE RESPONSIBLE FOR LOSS OF USE OF THE PRODUCT OR FOR OTHER INCIDENTAL, SPECIAL, OR CONSEQUENTIAL DAMAGE OR EXPENSES INCURRED BY PURCHASER, OR FOR LABOR OR OTHER COSTS DUE TO INSTALLATION OR REMOVAL, OR COSTS OF REPAIRS BY OTHERS, OR FOR ANY OTHER EXPENSE NOT SPECIFICALLY STATED ABOVE. EXCEPT TO THE EXTENT PROHIBITED BY APPLICABLE LAW, ANY IMPLIED WARRANTIES, INCLUDING THAT OF MERCHANTABILITY OR FITNESS FOR USE, ARE EXPRESSLY LIMITED TO THE DURATION OF THIS WARRANTY. SOME STATES DO NOT ALLOW LIMITATIONS ON HOW LONG AN IMPLIED WARRANTY LASTS, OR THE EXCLUSION OR LIMITATION OF INCIDENTAL OR CONSEQUENTIAL DAMAGE, SO THE ABOVE LIMITATION AND EXCLUSION MAY NOT APPLY TO YOU.

Important User Guidance Information



If you want to dispose this product, do not mix it with general household waste. There is a separate collection system for used electronic products in accordance with legislation that requires proper treatment, recovery and recycling.

Private households in the member states of the EU, in Switzerland and Norway may return their used electronic products free of charge to designated collection facilities or to a retailer (if you purchase a similar new one).

For countries not mentioned above, please contact your local authorities for the correct method of disposal.

By doing so you will ensure that your disposed product undergoes the necessary treatment, recovery and recycling, which prevent potential negative effects on the environment and human health.

Only discard discharged batteries. They should not be disposed of with household waste, but rather at appropriate collection sites or at the product retailer.

MEMO

MEMO

TOTO

Head Office

TOTO Europe GmbH
Peter-Müller-Str.16 D-40468 Düsseldorf Germany
Tel:+49 (0)700 8686 0700

- You are advised to record the following information to allow quick service.

Date of purchase :	Name of shop :
Date : year month day	
	Tel :